

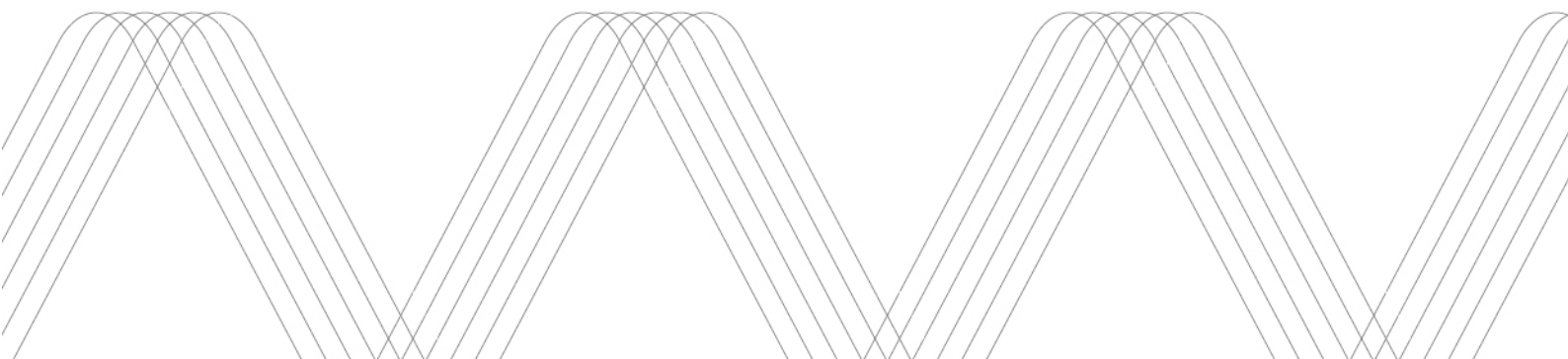

Charge Amps **Halo**

Installation Manual

3.7 kW, 7.4 kW and 11 kW





Care for the environment! Must not be discarded with household waste!
This product contains electrical or electronic components that should be recycled. Leave the product for recycling at the designated station e.g. the local authority's recycling station.



Disposal of the product must comply to the local environmental laws and guidelines. The product consists of recycled aluminium, plastic, and electronics, and should be recycled as specified for these materials.



Approved in accordance with the relevant EU directives.

Neglecting to follow and carry out the directions, instructions and safety precautions of this installation manual implies that any warranty provisions will be cancelled and that Charge Amps AB can reject any and all claims for compensation in connection with any injuries/damage or incidents – direct or indirect – that are a result of such negligence.

The manufacturer does not give any warranties as to the accuracy or completeness of this document and shall have no liability for the consequences of use of such information. The manufacturer reserves the right to make changes to information published in this document without notice. Visit www.chargeamps.com for the latest document releases.

© Copyright Charge Amps AB 2021. All rights reserved. Copying, amending and translating are strictly forbidden without prior written approval from Charge Amps AB.

Contents

1. Safety	4
2. Technical Data	5
3. Product overview	7
3.1. Parts.....	7
3.2. Package contents	8
4. Before Installation	8
4.1. Recommended tools	8
4.2. Materials provided by installer	8
4.3. Mounting requirements	9
4.4. Electric requirements	9
5. Installation	10
6. Configuration	14
6.1. Connect to WiFi	14
6.2. Connect via LAN	15
6.3. Local management interface settings	15
7. Cloud connectivity	17
7.1. Create a Charge Amps Partner account	18
8. Troubleshooting	18
8.1. Restart	18
8.2. Reset to factory default settings.....	18
9. Dismounting	19
10. Product support and service	19

1. Safety

WARNING! Read all instructions before use.

- The product must only be installed by a qualified electrician in accordance with the Installation Manual.
- Make sure to switch the power off at the main switch before installation or service.
- Improper use and negligence to follow the instructions of this Installation Manual may create a risk of personal injury.
- Local rules and regulations for installation apply.
- Only use this product for charging compatible electric vehicles.
- Inspect the product for visible damage before use.
- Never attempt to repair or use the product if it is damaged.
- Make sure that the product is in good condition and that all cables are properly seated before use.
- Do not immerse the product in water, subject it to physical abuse or insert foreign objects in any part of the product.
- Always store the EV connector in the holder when not in use.
- Never use an adapter between the EV connector and the electric vehicle.
- Make sure to always wind up the EV charging cable while not in use to prevent risk of damage to the cable and risk of tripping.
- Make sure to unwind the EV charging cable before charging to avoid overheating while in use.
- Never attempt to disassemble the product in any way.
- Make sure no flammable, explosive, corrosive or combustible materials, chemicals, or fumes are nearby the mounting position.
- Make sure that all terminal screws are securely fastened before reattaching the front cover.
- Be careful not to touch the circuit board during installation to prevent risk of static electricity.
- Heavy object! To avoid muscle strain or back injury, use lifting aids and proper lifting techniques.

2. Technical Data

Charging standard	Mode 3
EV power supply identifier	
Identification	RFID (i/a) HF, 13.56 MHz
Internet connection	WiFi 802.11b/g/n, 2.4 GHz
Metering	1 to 3-phase voltage, current and power
External RCD required	Yes, Type A
Operating temperatures	-30°C to +45°C
IP-rating	IP 66 (main unit) IP 44 (EV connector and socket-outlet)
Cable length	7.5 m
Dimensions (W x D x H)	Main unit: 262 x 159 x 203 mm Connector: 81 x 125 x 88 mm
Weight	4 kg
RFID Frequency Range	13.553–13.567 MHz
RFID Output	31 dBm
WiFi Frequency Range	2412–2484 MHz
WiFi Output	802.11 b/g/n: 20/17/14 dBm
Rated voltage (Un) (of the ASSEMBLY)	230/400 V
Rated operational voltage (Ue) (of a circuit of an ASSEMBLY)	230/400 V
Rated current of the ASSEMBLY (InA)	16/32 A* * Depending on variant
Rated current of a circuit (Inc)	16/32 A* * Depending on variant
Rated frequency (fn)	50 Hz
Residual-current safety functionality	DC fault current protection is integrated into the charging station. An external RCD type A is needed.

	Together, they have the same functionality as RCD type B and replace the requirement of an RCD type B according to IEC 61851.
Types of system earthing for which the charger is designed	TN, IT, TT
Indoor and outdoor installation	Yes
Stationary or movable	Stationary
Intended for use by ordinary persons	Yes
External design	Enclosed wall-mounted surface type ASSEMBLY
Type of construction	Fixed
Locations with restricted access or non-restricted access	Non-restricted access
Method of mounting	Wall mounted ASSEMBLY* * Stationary floor mounted installation with accessory Pole mount

3. Product overview

3.1. Parts

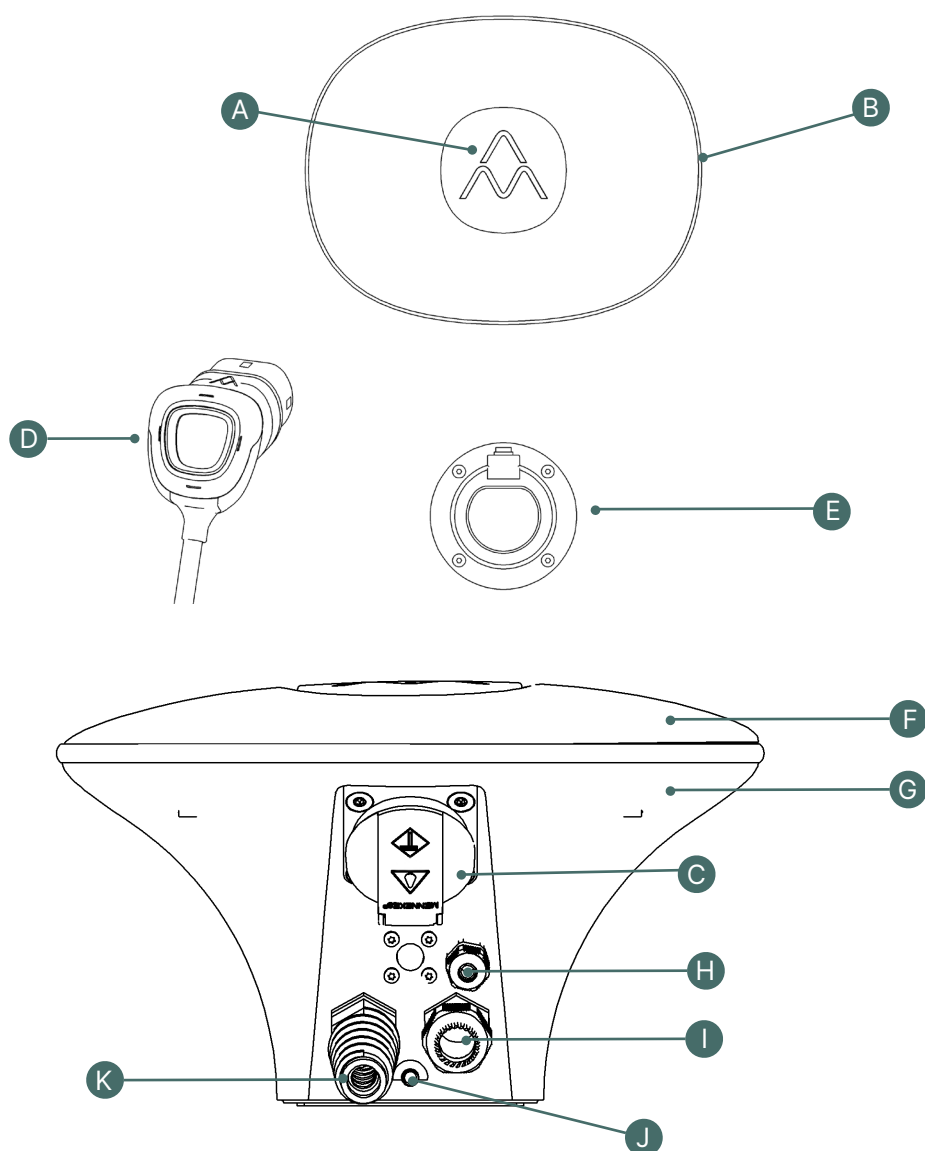

- A. Centre light / RFID reader
- B. Ring light
- C. Socket-outlet (*some models only*)
- D. EV connector

- E. EV connector holder
- F. Front cover
- G. Back cover
- H. Cable entry: LAN connection (*some models only*)
- I. Cable entry: incoming electrical connection
- J. WiFi-antenna entry (*some models only*)
- K. Cable entry: fixed charging cable

3.2. Package contents

- Charge Amps Halo
- WiFi antenna (*some models only*)
- Five-pin terminal connector for feed current
- EV connector holder
- RFID card
- Document with serial number and password
- Quick Guide User

4. Before Installation

4.1. Recommended tools

- Screwdriver; flat-bladed screwdriver for electrical installations 3.5 mm
- Drill for screw/plug for wall mount
- Laser/spirit level for proper mounting on the wall
- Wire stripper for cabling
- Angled Allen key H4

4.2. Materials provided by installer

- 3 x 5 mm flat head stainless screws type A2 or A4 with associated plugs (*if required*) for mounting of Charge Amps Halo
- 4 x 3.5 mm screws with recessed head for wall mounting of the EV connector holder
- External sealant for the wall (*if required*)
- External type A RCD, 30 mA
- Installation cable max 14.0 mm outer diameter, according to the charging capability of the selected product
- LAN cable with short connector head (*some models only*)

4.3. Mounting requirements

- **Make sure to always use sealant if installing in an outdoor environment or on an uneven surface.**
- If possible, do not mount Charge Amps Halo in direct sunlight.
- Do not install Charge Amps Halo in confined spaces.
- Make sure the wall can support the product weight.
- Recommended mounting height 750–1450 mm.
- Use screws and plugs (*if required*) suitable for the wall material.

4.4. Electric requirements

N.B. Local regulations might add additional requirements for the electrical installation.

- Charge Amps Halo must be earthed through permanent electrical installation.
- Only insert the electrical cable through the specified cable entry.
- The cable ethernet connector must be of short type.
N.B Ethernet connection is only available for Charge Amps Halo OCPP version.

4.4.1. Check the following before installation

- The power is switched off at the main switch.
- The incoming cabling is dimensioned to be able to connect the Charge Amps Halo:
 - Minimum 2.5 mm² for 16 A
Electrical conditions in the facility and cable lengths may require a higher cross-sectional area to meet the triggering conditions.
The selected cable's outer diameter cannot exceed 14.0 mm.
 - Minimum 6 mm² for 32 A
Electrical conditions in the facility and cable lengths may require a higher cross-sectional area to meet the triggering conditions.
The selected cable's outer diameter cannot exceed 14.0 mm.
- The product is properly fused:
 - 1-phase 3.7 kW: 16 A, C or B Curve MCB*
 - 3-phase 11 kW: 16 A, C or B Curve MCB*
 - 1-phase 7.4 kW: 32 A, B Curve MCB*

These are minimum levels. Local regulations must always be fulfilled.

* MCB = Miniature Circuit Breaker, B Curve MCB's trip at 3-5 times rated current and C Curve MCB's trip at 5-10 times rated current.

- Make sure an RCD Type A is installed.
DC fault current protection is integrated into the charging station. An external RCD type A is needed. Together, they have the same functionality as RCD type B and replace the requirement of an RCD type B according to IEC 61851.

5. Installation

1. Switch off the power at the main switch.
2. Make sure that the feed cable is isolated.
3. Unpack Charge Amps Halo.
4. Mount a separate type A RCD on the feed line to the Charge Amps Halo.
5. Open the Charge Amps Halo with an Allen key H4.
Make sure that the O-rings securing the screws do not come loose.

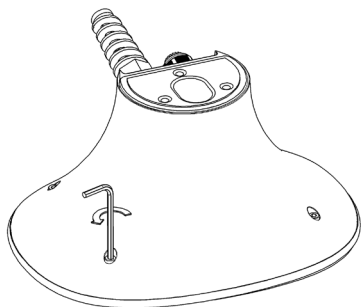

6. Remove all connected terminal blocks/connectors from the circuit board.
7. Mount the external WiFi antenna (*some models only*).

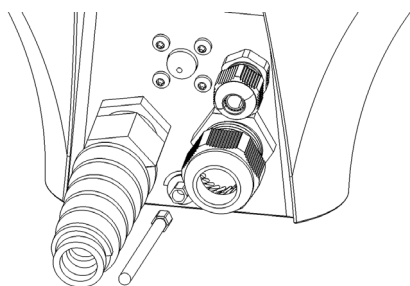

8. Install the ethernet cable via the LAN connection. Max diameter 4-8 mm.
9. Mark and drill mounting holes on the wall for the Charge Amps Halo.

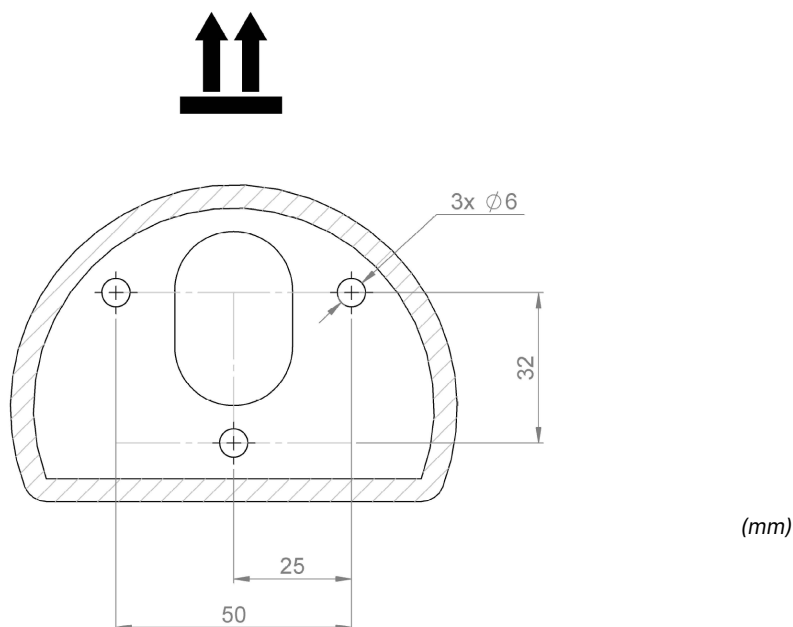

Not to scale.

Marked area is the sealing area that puts pressure on the wall.

Make sure that this area is flat and clean to ensure no water leakage.

10. Mount the back cover on to the wall. Make sure the mounting surface is vertical and flat.

Important!

Make sure to always use sealant.

11. Mark and drill mounting holes on the wall for the EV connector holder.
Place the holes for the EV connector holder approximately 30 cm to the right of Charge Amps Halo.
12. Mount the EV connector holder.
13. Loosen the cable entry nut.
14. Strip the electrical cable (15-20 cm) and insert through the cable entry.
15. Retighten the cable entry nut.
16. Attach the power supply into the 5-pin terminal block.

- **Connection in TN and TT network**

3.7 kW, 7.4 kW

Connect L1, N and PE.

L2 and L3 are optional but recommended.

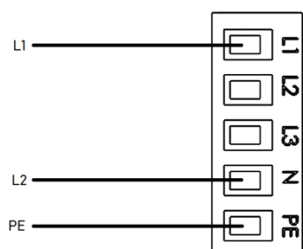
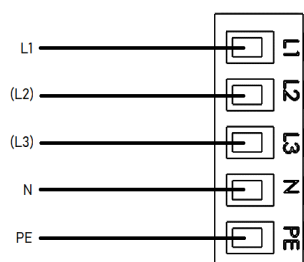

17. Refit the terminals in the front cover.

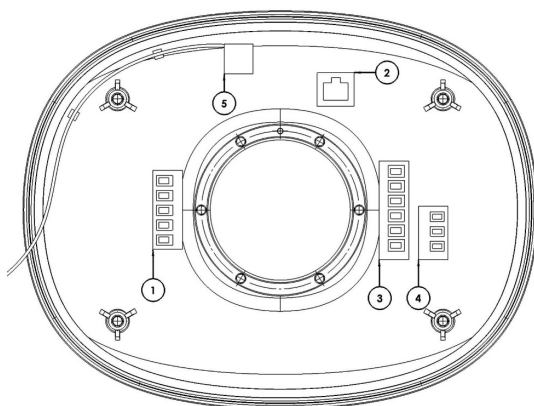

1. 5-pin terminal block for incoming power supply
2. Ethernet port (*if connected by wired network*)
3. 6-pin terminal block for charging cable
4. 3-pin terminal block for socket-outlet (*some models only*)
5. WiFi antenna cable (*some models only*)

18. Refit the front cover to the back cover.

Carefully check that:

- All O-rings around the fastening screws are in place.
- No cables are pinched.
- All cables are properly seated.
- The front cover is mounted with Charge Amps logo facing the upright direction.



19. Tighten the four H4 Allen head screws with a torque of 1.5–2.0 Nm.

20. Switch the power on at the main switch.

- A start-up sequence with self-test begins.
- Once Charge Amps Halo is illuminated with a steady white light, it is ready for use.

21. Continue the installation by configuring Charge Amps Halo.

6. Configuration

6.1. Connect to WiFi

6.1.1. Access Charge Amps Halo WiFi access point

N.B. Not needed if LAN is used (*some models only*). See chapter 6.2 *Connect via LAN*.

Charge Amps Halo WiFi access point is not connected to a network.

Charge Amps Halo WiFi access point is only accessible within 10 minutes after power on.

1. Connect to Charge Amps Halo WiFi using a smartphone, tablet or a computer. To avoid conflicting WiFi, set to airplane mode.
 - SSID: HALO_nnnnnnM (nnnnnn equals the last 6 digits of the serial number).
 - Password: Enter the Charge Amps Halo pin-code.
2. Start a web browser and type in 192.168.250.1 as search path.
3. Proceed to the chapter according to the table below.

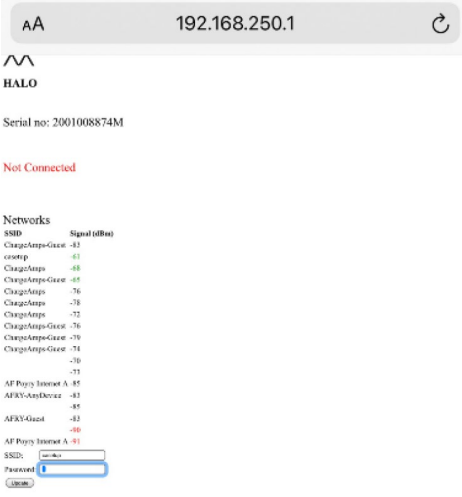
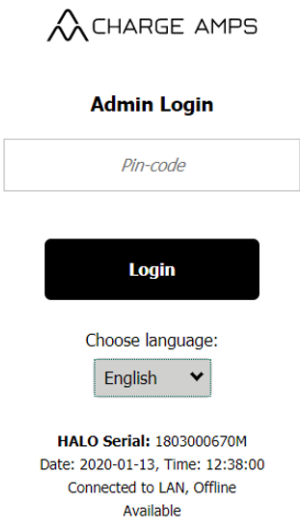
<p>Charge Amps Halo</p> <p>See chapter <i>6.1.2 Connect to WiFi</i></p>	<p>Charge Amps Halo OCPP version</p> <p>See chapter <i>6.1.3 Connect to WiFi</i></p>
	

6.1.2. Connect to WiFi

1. Enter the sign in details of the facility network to connect Charge Amps Halo to internet.
2. Click *Refresh* to save.

6.1.3. Connect to WiFi

N.B. Only available for Charge Amps Halo OCPP version.

N.B. Not needed if LAN cable is used.

1. Sign in to the local management interface
Enter the pin-code and sign in to the local management interface.
2. Click on the arrow in the top right corner to navigate between tabs. Select the *WiFi* tab.
3. Enter the sign in details of the facility WiFi to connect Charge Amps Halo to internet.
4. Click *Refresh* to save.

6.2. Connect via LAN

N.B. Only available for Charge Amps Halo OCPP version.

1. Make sure that Charge Amps Halo is connected to the local network via LAN cable.
2. Start a web browser using a computer or smart phone and enter the IP-address assigned to Charge Amps Halo as search path.
The IP-address can be seen in the router or DHCP-server that manages the distribution of IP-addresses.
3. Enter the pin-code and sign in to the local management interface.

6.3. Local management interface settings

N.B. Only available for Charge Amps Halo OCPP version.

Click on the arrow in the top right corner to navigate between tabs.

6.3.1. Electrical installation settings

1. Select the *Installation* tab and follow the instructions.
2. Click *Refresh* to save.

6.3.2. RFID management for offline chargers

N.B. If connecting to a cloud service, the locally added RFID cards are ignored.



1. Select the “RFID” tab and follow the instructions.
2. Click *Refresh* to save.

6.3.3. Connect cloud provider

N.B. Not applicable for Charge Amps Cloud users.

1. Select the OCPP tab and enter the cloud provider url.
2. Click *Refresh* to save.

7. Cloud connectivity

Charge Amps Cloud and Charge Amps App are available for Charge Amps Halo connected to Charge Amps as cloud provider.

For Charge Amps Halos connected to other cloud providers, please refer to the cloud provider for inquiries about portals and apps.

Contact the cloud provider to verify a successful connection.

Charge Amps **App**



Charge Amps **Cloud User**



<https://my.charge.space/>

Charge Amps **Cloud Partner**



<https://my.charge.space/partner>

Visit link to find full product documentation.



<https://www.chargeamps.com/product/charge-amps-halo/>

7.1. Create a Charge Amps Partner account

Installation of Charge Amps products require a Charge Amps Partner account.

Use your login credentials or create a new account.

1. Create a User account at Charge Amps Cloud <https://my.charge.space/>
N.B Do not register the EV charger. Configuration is made in the Partner interface.
2. Send an email to Charge Amps (support@charge-amps.com) stating the following:
 - a. User account login name
 - b. Company name
 - c. Company postal address
 - d. Company email
 - e. Company phone number
 - f. Company organization number
 - g. Company representative
3. Charge Amps will notify you by email when your Partner account has been created.

8. Troubleshooting

8.1. Restart

- Restart by power cycle the charger.
- Restart the charger using the local management interface.
Navigate to the tab "System" and click on "Reboot system".
- As a last resort, perform a factory reset.

8.2. Reset to factory default settings

N.B. Contact the supplier before performing this action.

Restore the charger to factory settings using the local management interface.
Select the tab "System" and click on "Factory Reset".

9. Dismounting

N.B. Dismounting shall only be performed by an authorized electrician.

Perform a factory reset of Charge Amps Halo before powering it down. Contact the supplier before performing this action.

The power supply to the charger must be isolated before dismounting starts.

Use this installation manual and follow the steps in reverse to dismount Charge Amps Halo in the correct order.

10. Product support and service

If your question is not answered in the manual, please contact the supplier or cloud provider, see <https://chargeamps.com/support/>.